

e-Golf

Model Year 2020 Specifications



5 YEAR WARRANTY

Price

e-Golf

Model Code	BE23D1
Maximum Retail Price**	\$69,490

**Maximum Retail Price (MRP) does not include on-road costs. Specifications are as planned at January 2020 for Model Year 2020 and subject to change without notice or obligation.
*Exterior colours: Subject to change without notice or obligation. †Optional 'Madrid' alloy wheels could reduce your real-world range by approx. 7km over the standard alloy wheels.



Technical Data

e-Golf

Electric Motor Type	Synchronous AC Permanent Magnet
Maximum Power (kW) @ rpm	100kW
Maximum Torque (Nm) @ rpm	290Nm
Drivetrain	Front Wheel Drive
Transmission	Single Speed reduction gear
Battery Type	Lithium-ion
Battery Capacity	35.8kWh
Electric Range (AA Tested: Two passengers, air-conditioning on, e-Golf in 'Normal' drive mode from Auckland to Tokoroa)	220km Real World
Energy Consumption (kWh/100km) (Combined)	12.7
On Board Charger	Maximum power 7.2kW
Charging time (Domestic AC 3-Point Plug, 1.8kW 0 - 100%)	Approx. 21 Hours
Charging time (Wallbox with single phase, 3.6kW 0 - 100%)	Approx. 11 Hours
Charging time (Wallbox with 3-phase, 7.2kW 0 - 100%)	Approx. 5 Hours 30 mins
Charging time (DC Rapid Charger, 40kW 0 - 80%)	Approx. 45 Mins
Charging Socket	Type 2 / CCS
1 x Trickle charger	●
1 x Type2 to Type2 cable (AC Public charging)	●
Tare weight (kg)	1,615
Luggage Capacity (L) (rear seats upright / rear seats folded)=	341 / 1,231
5 year / 150,000 km (whichever occurs first) mechanical warranty, 5 year VW roadside assistance and 12 year anti-corrosion warranty and 8 year / 160,000 km battery warranty.	●

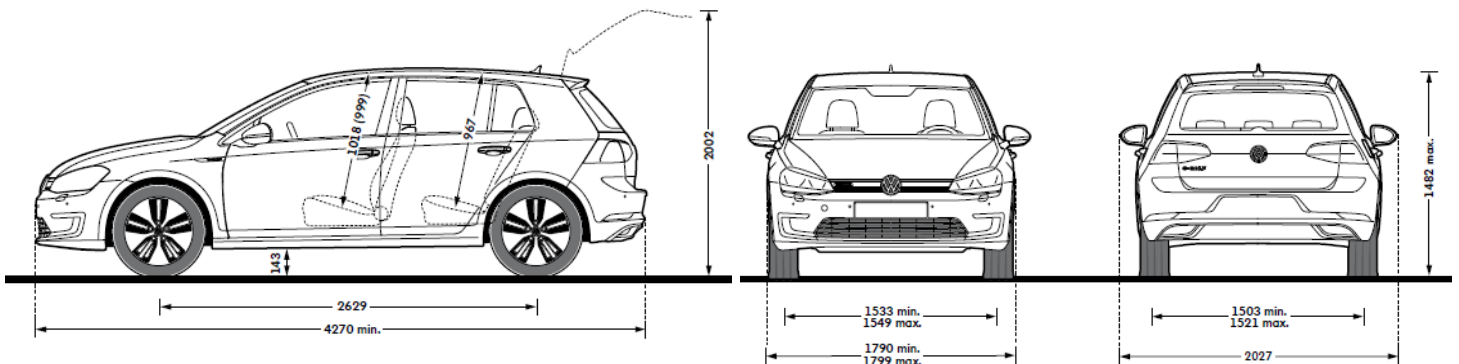



Safety and Security

e-Golf

Electronic Stability Programme (ESP)	●
Multi-collision Brake	●
Driver and front passenger airbags, curtain airbags, front side airbags	●
Driver knee airbag	●
Tyre pressure warning light (indirect measurement)	●
Safety-optimised front head restraints	●
ISOFIX mounting points on outer two rear seats for child seats	●
Warning tone and lamp if front seats belts are not fastened	●
Anti-theft 'Plus' alarm system with electronic immobiliser	●
Proactive passenger protection system	●
'Rest Assist' driver fatigue detection	●
'Front Assist' incl. Autonomous Emergency Braking (City) and Forward Collision Warning	●
Pedestrian monitoring	●
Adaptive Cruise Control (ACC) with Traffic Jam Assist and Emergency Assist	●
Lane Assist (Lane Keeping System)	●
'Side Assist Plus' (Blind Spot Monitor) and Rear Traffic Alert	●
Rear view camera	●
Park Distance Control (Front and Rear parking sensors)	●



e-Golf exclusive Drive Modes

e-Golf

Driving Profile Selection (Normal, ECO, ECO+)	●
Acceleration 0 - 100km/h (Normal / ECO / ECO+)	9.6sec / 13.0sec / 19.0sec
Electric Motor Maximum Power Output (Normal / ECO / ECO+)	100kW / 70kW / 40kW
Top Speed (Normal / ECO / ECO+)	150km/h / 115km/h / 90km/h



Exterior

e-Golf

LED Headlights with LED separate daytime running lights (DRL)	●
Low light sensor with automatic headlight function	●
Dynamic cornering light	●
Rear LED combination Tail lamps with dynamic turn signal	●
Rear fog lamp	●
'leaving home' and manual 'coming home' function	●
Rain sensing front wipers	●
Privacy glass - Rear side windows and rear window	●
Electrically folding & heated exterior mirrors	●



Interior

e-Golf

"KESSY" - Smart key, Push button start and Keyless entry/locking with SAFELOCK	●
Air Care Climatronic two-zone air conditioning system with allergen filter	●
Leather-wrapped multifunction steering wheel	●
Leather-covered gear shifter knob	●
Electronic Park Brake with Auto-hold	●
'Polar Night Black' inserts for dashboard on driver side and centre console	●
'New Brushed Dark Metal' inserts for dashboard on front passenger side and door trim panels	●
Front centre armrest with storage box	●
Glove compartment with cooling facility and illuminated	●
Storage pockets at the rear of the front seats	●
Variable cargo area with bag hooks	●



Seat & Upholstery

e-Golf

Comfort front seats with 'Zoom' fabric seat material	●
'Vienna' leather appointed upholstery#, heated front seats (WLO) <small>(#Leather appointed seats have a combination of genuine and artificial leather, but are not wholly leather)</small>	\$3,500
Driver and front passenger seat height manual adjustment and lumbar support	●
Asymmetrically split folding backrest, with centre armrest with 2 x cup holders and load through provision	●



Multimedia



e-Golf

9.2" Discovery Pro Satellite navigation system with gesture control	●
App-Connect (Apple CarPlay®, Android Auto™ and MirrorLink™)	●
Volkswagen Media Control	●
1 x USB Port front	●
Standard 8 speakers	●
Voice control	●
Active Info Display (12.3" High-resolution full TFT-LCD instrument cluster)	●



Wheels





e-Golf

Image (Standard Wheel)	
Standard Wheel (Size)	16" Astana Alloy Wheel (205/55 R16 Low rolling resistant tyres)
Image (Optional Wheel#)	
Optional Wheel# (Size)	17" Madrid Alloy Wheel (225/45 R17 Low rolling resistant tyres) [\$1,500]
Tyre mobility set with 12V compressor and tyre sealant	●



Exterior Colours°

e-Golf

Pure White (0Q0Q)		●
Deep Black Pearlescent (2T2T)		●
Indium Grey Metallic (X3X3)		●
Atlantic Blue Metallic (H7H7)		●
Tungsten Silver Metallic (K5K5)		●